

SOUTH POLARITY WARPED
BY STEEL HOUSING TO
FACE THE OTHER DIRECTION

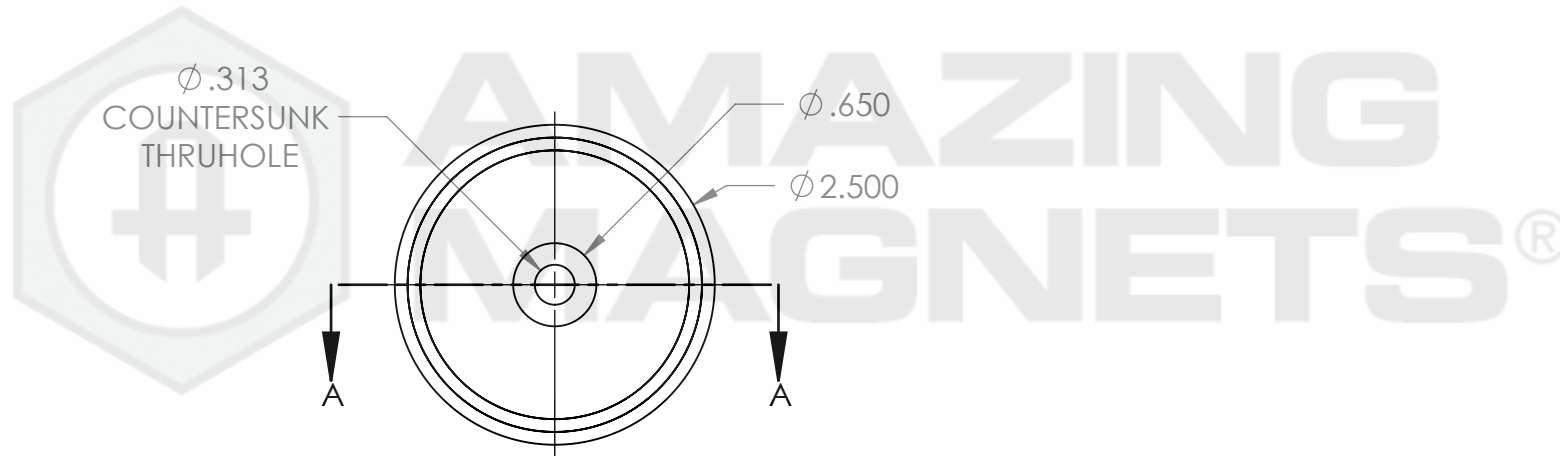

SECTION A-A

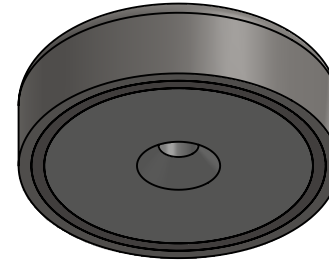
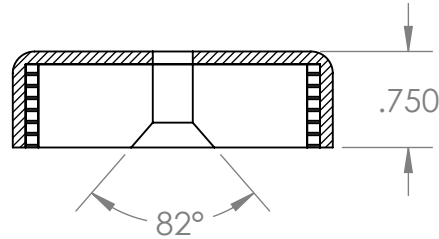

GRADE: N40
MAGNETIZED: YES
RESIDUAL INDUCTION (Br): 12.5-12.8 KG
COERCIVE FORCE (Hc): ≥ 11.4 KOe
INTRINSIC COERCIVE FORCE (Hci): ≥ 12.0 KOe
MAX. ENERGY PRODUCT (BHmax): 38-41 MGOe
MAX OPERATIONAL TEMP: 80C / 176F

PROPRIETARY AND CONFIDENTIAL
THE INFORMATION CONTAINED IN THIS DRAWING IS THE SOLE PROPERTY OF AMAZING MAGNETS LLC. ANY REPRODUCTION IN PART OR AS A WHOLE WITHOUT THE WRITTEN PERMISSION OF AMAZING MAGNETS LLC IS PROHIBITED.
CAGE CODE 4R1R7

UNLESS OTHERWISE SPECIFIED:
DIMENSIONS ARE IN INCHES TOLERANCES: FRACTIONAL ± 1/64 ANGULAR: MACH ± 1° TWO PLACE DECIMAL ± 0.01 THREE PLACE DECIMAL ± 0.005
MATERIAL: NdFeB
FINISH: Ni-Cu-Ni (silver in Color)
DO NOT SCALE DRAWING

NAME	DATE
DRAWN LB	2/6/2012
CHECKED TB	2/6/2012
COMMENTS: ALL EDGES BROKEN 0.025 MAX	



**AMAZING
MAGNETS®**

TITLE: **CUPT2500**

SIZE A	DWG. NO. CUPT2500-SPECS	REV 0
------------------	----------------------------	-----------------

SCALE 2 : 3

5

4

3

2

1